



**Vibro**

Where ground improvement begins

Geotechnical solutions for the construction industry

# Overview of deep vibro techniques



## The subsoil

Soil conditions are usually described in a soil investigation report. If the properties do not fulfil the design requirements, deep vibro techniques offer an economical solution for ground improvement and can be carried out to almost any depth.

## The depth vibrator

The cylindrical depth vibrator is typically between 3m and 4m long and weighs approximately 2 tons. The core element of the vibrator is an electrically driven eccentric weight which induces the horizontal oscillation of the vibrator. The vibrator string is assembled with the vibrator and extension tubes to suit the improvement depth and suspended from a crane or mounted on a custom-built rig (eg the Keller Vibrocat).

## The techniques

The depth vibrator is used for three distinct techniques which differ in both their soil-improvement and in their load-transfer mechanisms. The foundation design is therefore frequently developed by Keller in close

co-operation with the consultant's geotechnical and structural engineers.

The Vibro compaction technique compacts granular soils with negligible fines content by re-arranging the soil particles into a denser state.

The Vibro replacement technique builds load-bearing columns made from gravel or crushed stones in cohesive soils, and in granular soils with a high fines content.

The third technique creates structural foundation elements in the ground which will allow comparatively high loads to be safely carried by soils where no adequate lateral support for Vibro Replacement columns can be mobilised.

## The execution

For all techniques the vibro process starts with the penetration of the oscillating depth vibrator into the ground to the required improvement depth. Subsequently, the vibrator is withdrawn as required by the employed technique to either compact the soil from the bottom up, to construct a stone column, or to construct a structural foundation element.

# Overview

Deep vibro techniques offer flexible solutions for ground improvement. They are mainly used under foundations of structures to be constructed on soils of low bearing capacity. Keller developed the depth vibrator (patented in 1934), which was originally used to compact granular soils such as sand and gravel. Today, Keller improves a variety of granular and cohesive soils employing a wide range of depth vibrator models and techniques.

## The benefits

The deep vibro techniques present a very versatile ground improvement method that can be adjusted to a wide variety of soil conditions and foundation requirements. Its execution is comparatively fast even if large volumes of soil are to be improved and subsequent structural works can follow very quickly. The soil improvement enables the contractor to utilise standard shallow footings which, in turn, leads to additional savings.

Another advantage is the environmental friendliness of the deep vibro techniques, as natural and in situ materials are used. In addition, only a comparatively small quantity of soil is removed during the process.

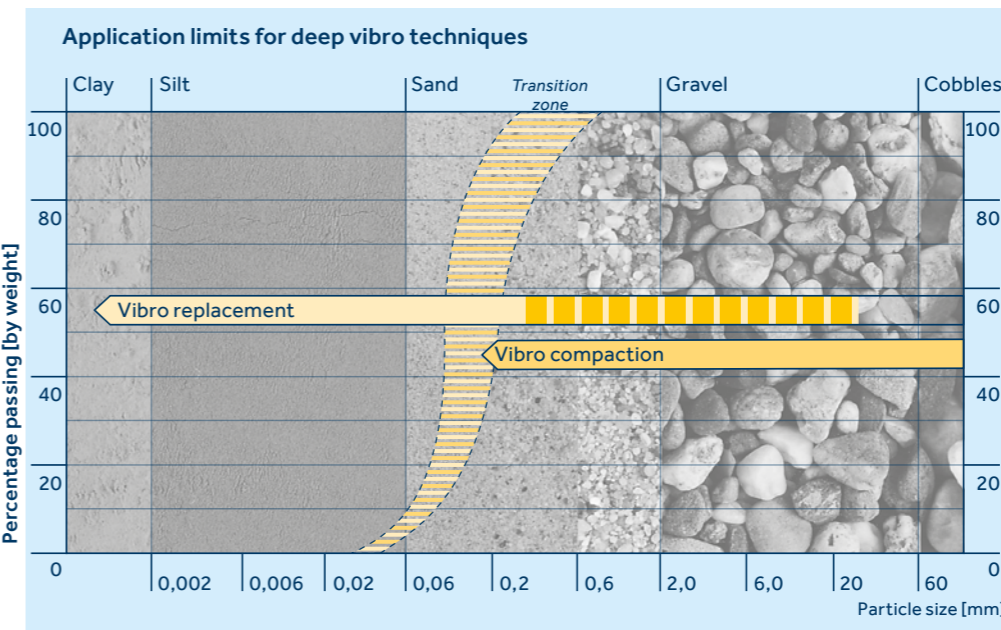

## Operating principle

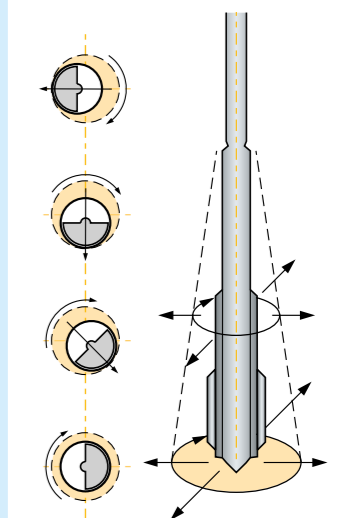

# Vibro compaction in granular soils

## Equipment and execution

The compaction of granular soils is most economically realised with vibrators oscillating at a comparatively low frequency to achieve optimum compaction of the soil particles. The vibrator is typically suspended from a crawler rig or crane. The penetration of the vibrator, and to a certain extent the compaction process, is aided by water flushing with jets of variable pressures. The pressure pipes and jets form an integral part of the vibrator string. The compaction is carried out from the lowest point of penetration upwards in predetermined pull out steps and compaction intervals. The compaction result is dependent on the effectiveness of the vibrator and the soil conditions.

## Geotechnical aspects

Under the influence of the induced vibration, the soil particles within the zone of influence are rearranged and compacted. The extent of this zone depends on the vibrator used, the soil, and the method employed. The volume reduction of the compacted soil can reach values of the order of 15 % depending on the soil conditions and the intensity of the compaction effort.

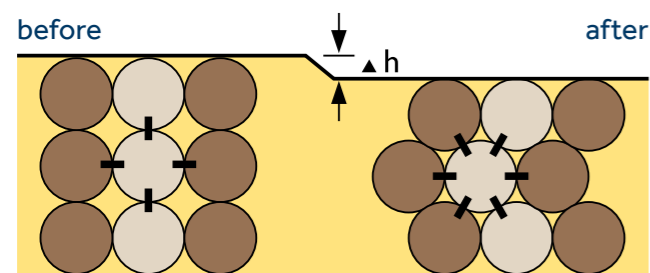

## The foundation concept

The range of compaction for an individual point is governed by several parameters. Keller is able to draw upon a wealth of experience to propose

a suitable foundation concept. The optimum arrangement of the vibro compaction points is usually best achieved by an on-site trial, where different compaction grids and methods can be tested and evaluated. After compaction, high loads can be safely carried and foundation pressures of up to 1 MN/m<sup>2</sup> can be reached. The layout of the compaction points can be adjusted so that soil volumes of any size are compacted. The achieved degree of compaction can be easily and economically verified using a range of different tests.

Compaction below raft footings

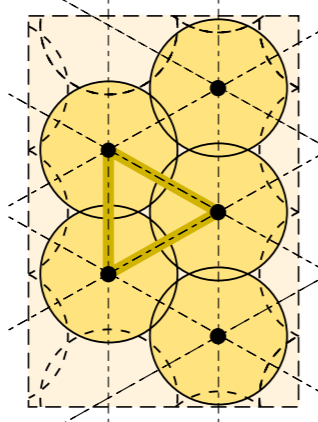

Compaction below single footings

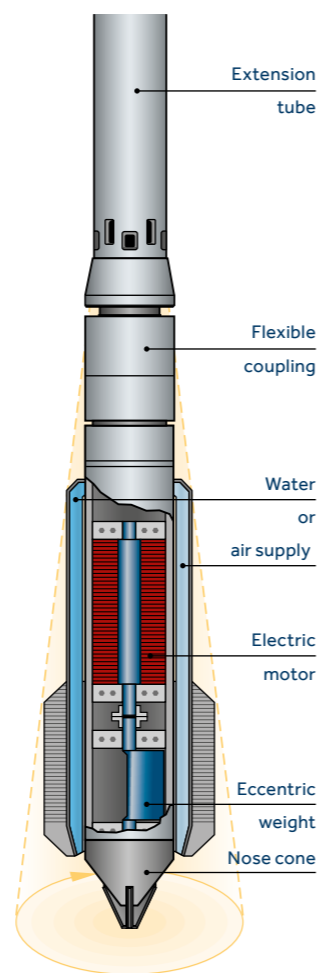
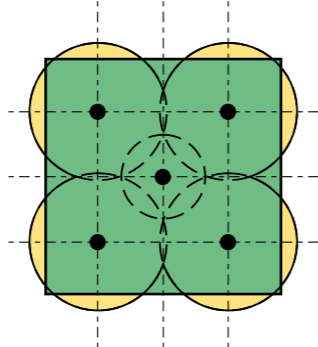

# Technical highlights

The vibro compaction technique compacts granular soils with negligible fines content by re-arranging the soil particles into denser state.

## The process

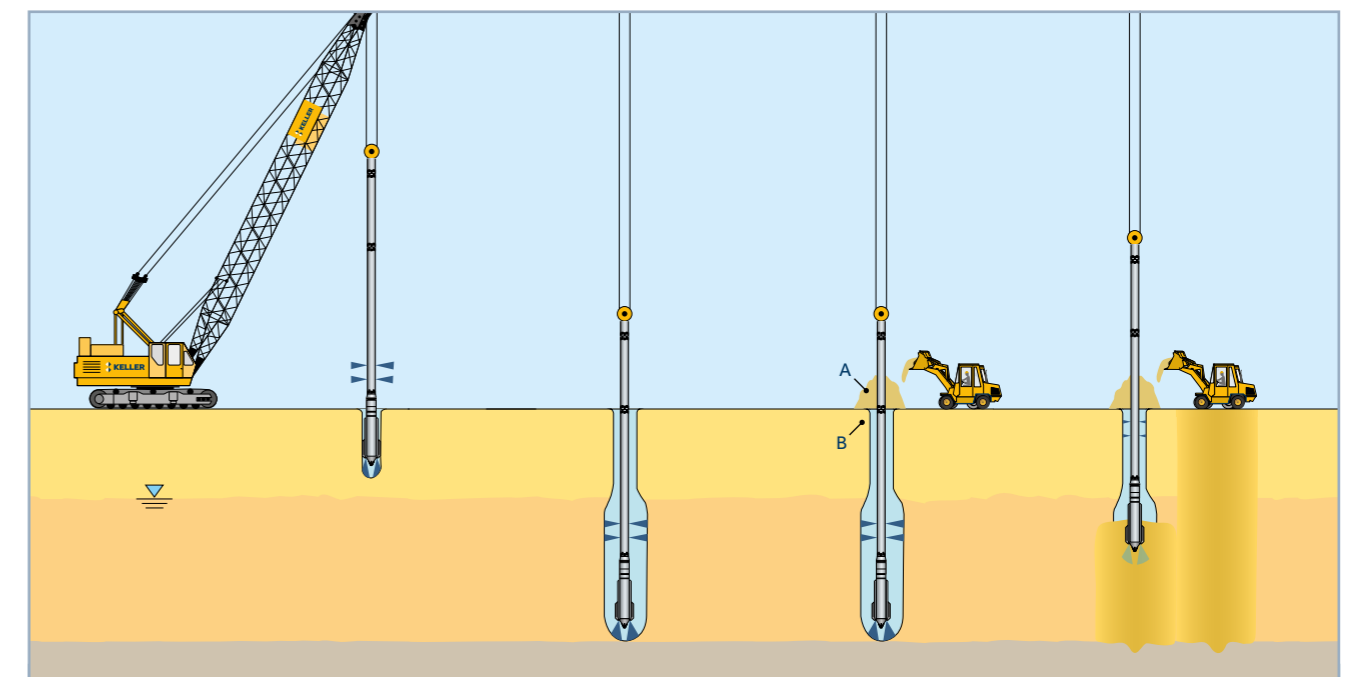

### 1. Penetration

At full water pressure the oscillating vibrator penetrates to the design depth and is surged up and down as necessary to agitate the granular soil, remove fines and form an annular gap around the vibrator. At full depth the water flow is reduced.

### 2. Compaction

The compaction is carried out in steps from the maximum depth of penetration upwards. It encompasses a cylindrical soil body of up to 5 m diameter. The increase in density is indicated by an increased power consumption of the vibrator.

### 3. Backfilling

Around the vibrator a crater develops which is backfilled with sand, which is either imported (A) or taken from the existing soil (B). For this purpose a volume of up to 15 % of the treated soil volume is required.

### 4. Finishing

After completion of the compaction, the surface is re-levelled and compacted with a vibratory roller.

## Benefits of vibro compaction

- Reduces foundation settlement
- Increases bearing capacity, allowing reduction in footing size
- Increases stiffness
- Increases shear strength
- Can reduce permeability
- Mitigates liquefaction potential
- Provides slope stabilisation
- Permits construction in fills
- Permits shallow footing construction
- Prevents earthquake-induced lateral spreading

# Vibro replacement in granular soils with high fines content and in cohesive soils

## Equipment and execution

For the construction of vibro replacement columns the bottom feed process is frequently employed, which feeds coarse granular material to the tip of the vibrator with the aid of pressurised air. To optimise the performance of this process and to accommodate the specialised equipment, Keller has developed the Vibrocat base unit which guides the vibrator on its leader and allows additional pull-down pressure to be exerted during penetration and compaction. The vibro replacement process consists of alternating steps. During the retraction step, gravel runs from the vibrator tip into the annular space created and is then compacted and pressed into the surrounding soil during the subsequent re-penetration step. In this manner stone columns are created from the bottom up, and these behave as a composite material with the surrounding soil under load.

## Geotechnical aspects

In so far as any compaction can be achieved in mixed or fine-grained soils through horizontal vibration and soil displacement (which depends mainly on their degree of saturation), this improvement should be evaluated in the same manner as vibro compaction. The pure vibro replacement process, however, does not assume any compaction in the surrounding soil. The improvement relies on the greater stiffness and higher shear strength of the stone column as well as the annular zone.

## The foundation concept

While the compaction of the surrounding soil can be easily verified by soundings, the improvement effect of the vibro replacement can only be checked by in-situ load tests.

Keller has developed a reliable design method which uses the geometry of the columns and the friction angle of the column material as input parameters. For the foundation design, the improved ground is treated like normal subsoil. The allowable bearing pressure achieved after the improvement is typically in the range of 150 to 400 kPa.

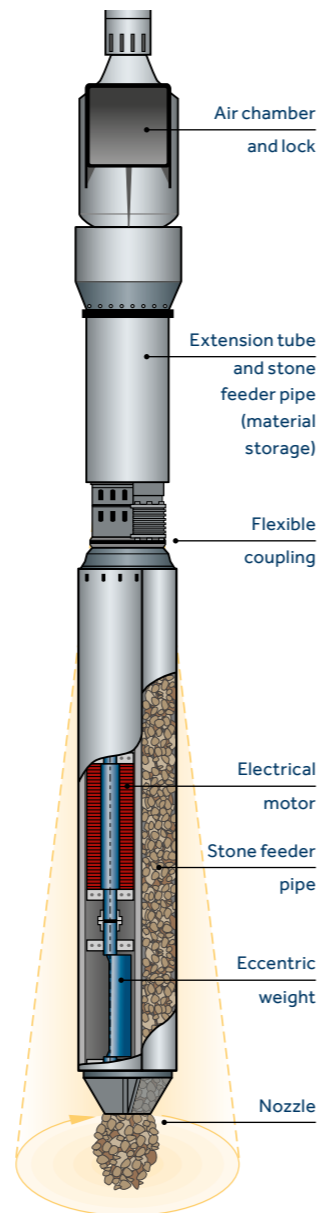
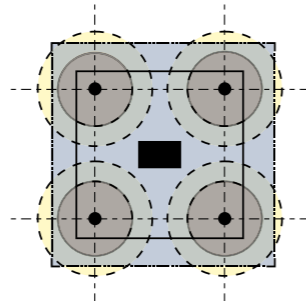
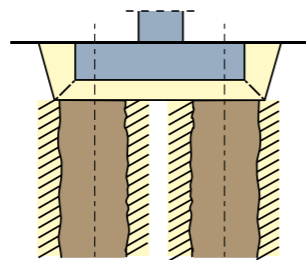
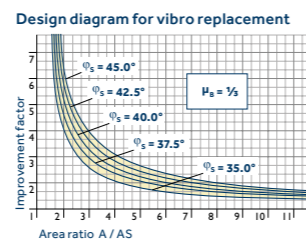

# Technical highlights

The vibro replacement technique builds load-bearing columns made from gravel or crushed stones in cohesive soils, and in granular soils with a high fines content.

## The process

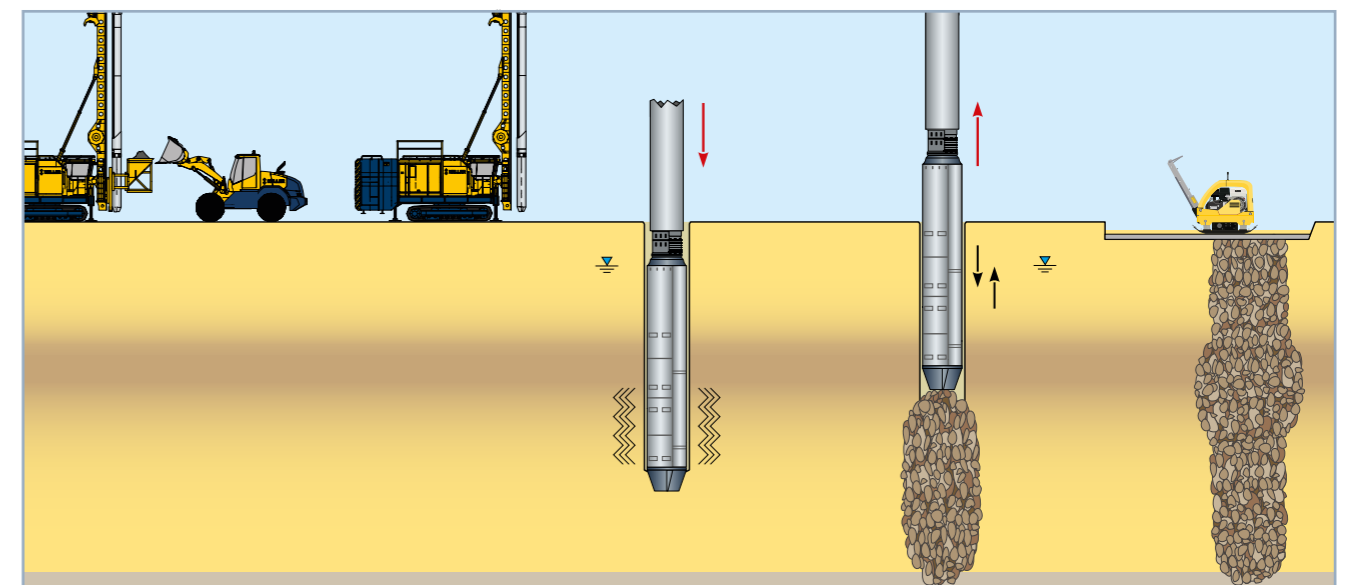

### 1. Preparation

The Vibrocat positions the vibrator over the required location of the compaction point and stabilises itself using hydraulic supports. A wheel loader fills the skip with aggregate.

### 2. Charging

The skip is lifted and empties its contents into the air chamber. Once the air lock is closed, the material flows towards the vibrator tip assisted by pressurised air.

### 3. Penetration

The vibrator displaces the soil and is lowered to the design depth, aided by the compressed air and by the Vibrocat's pull-down pressure.

### 4. Compaction

After reaching the maximum depth the vibrator is pulled up slightly, causing the aggregate to fill the cavity created. During re-penetration the aggregate is compacted and pressed into the surrounding soil.

### 5. Finishing

The stone column is built up in alternating steps to the design level. During the final levelling, the surface needs to be re-compacted, or a blinding layer is required as an alternative.

## Benefits of vibro replacement

- Reduces foundation settlement
- Increases bearing capacity, allowing reduction in footing size
- Increases stiffness
- Increases shear strength
- Allows quick drainage of excess pore-water
- Mitigates liquefaction potential
- Provides slope stabilisation
- Permits construction in fills
- Permits shallow footing construction
- Prevents earthquake-induced lateral spreading

# Structural foundation elements



## Premixed vibro concrete columns (PVCC)

### Equipment and execution

These foundation elements are built in the same manner as described for the vibro replacement process. For premixed vibro concrete columns, a special coarse-grained concrete mix with a strength typically ranging between C8/10 and C20/25 is installed. It behaves identically to the stone material, allowing the same compaction and displacement effects in the surrounding soil.

### Geotechnical aspects

The load bearing behaviour of the rigid foundation elements is largely identical to the behaviour of piles.

### The foundation concept

For premixed vibro concrete columns, Keller has the approval of the German supervisory board for construction (Agrément Board). The external load-bearing mechanism used in the design of the soil improvement is very well supported by a large number of load test results as per DIN 1054. Depending on the soil conditions and the materials used, loads of up to 900 kN can routinely be achieved. Vibro concrete columns can be easily combined with the normal vibro replacement method by eliminating the use of concrete in the upper or lower section of the column as required. This is to create a buffer or transition zone to the rigid concrete columns.

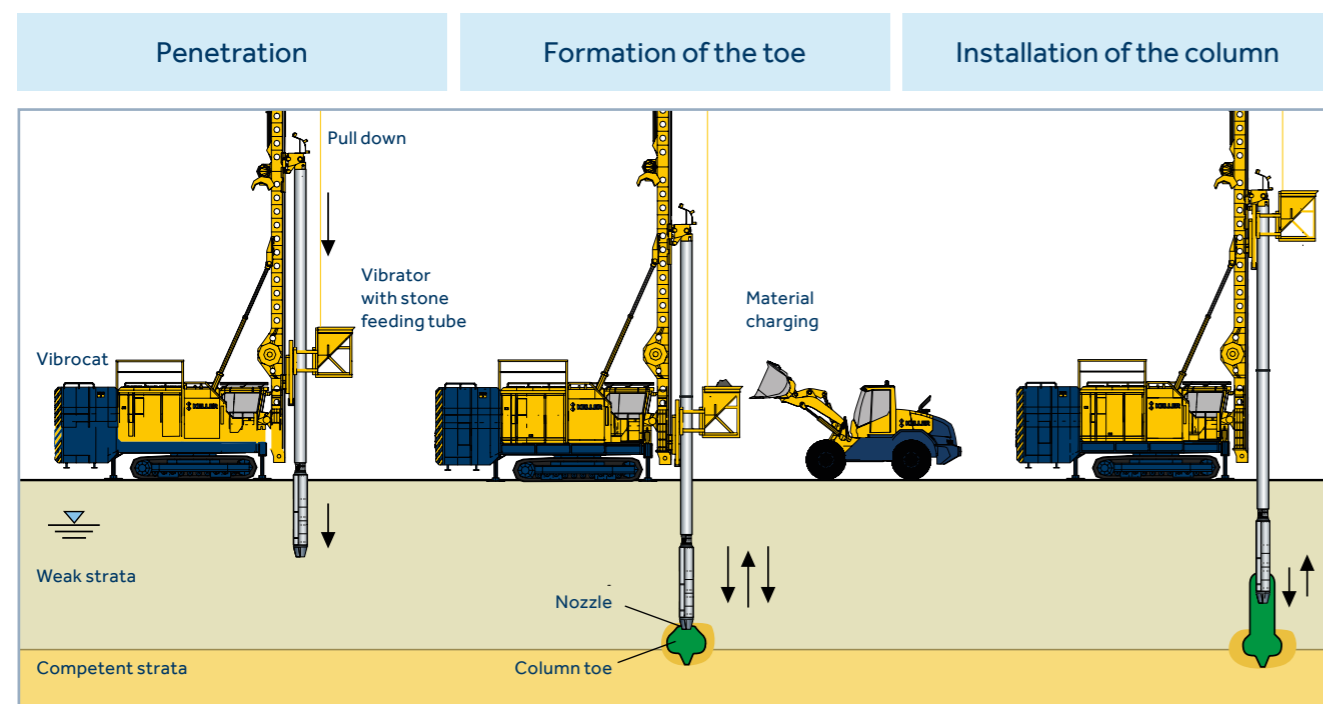

# Technical highlights

- The aggregate is always fed directly to the tip of the vibrator, creating a continuous column.
- Only a single penetration is required.
- The collapse of the hole is not possible due to the compressed air, even in critical soils.

## Vibro concrete columns (VCC)

### Equipment and execution

Vibro concrete columns typically consist of pumpable, C25/30-strength concrete. The toe of the column is enlarged by repeated retraction and re-penetration of the vibrator, but the shaft is built in a single pull due to the high internal strength of the concrete.

### Geotechnical aspects

During the installation of vibro concrete columns no particular effort is made to densify any specific soil layer. As with other structural foundation elements, a high degree of improvement can be achieved at the toe of the column, and this leads

to a particularly high bearing capacity and low deformations under load.

### The foundation concept

For vibro concrete columns, Keller also has the approval of the German supervisory board for construction. Vibro concrete columns are generally more slender compared to other structural foundation elements. Typical shaft diameters range between 40 cm and 60 cm. The bearing capacity under working load can reach 1000 kN depending on the ground conditions and on the extent to which the toe can be enlarged.

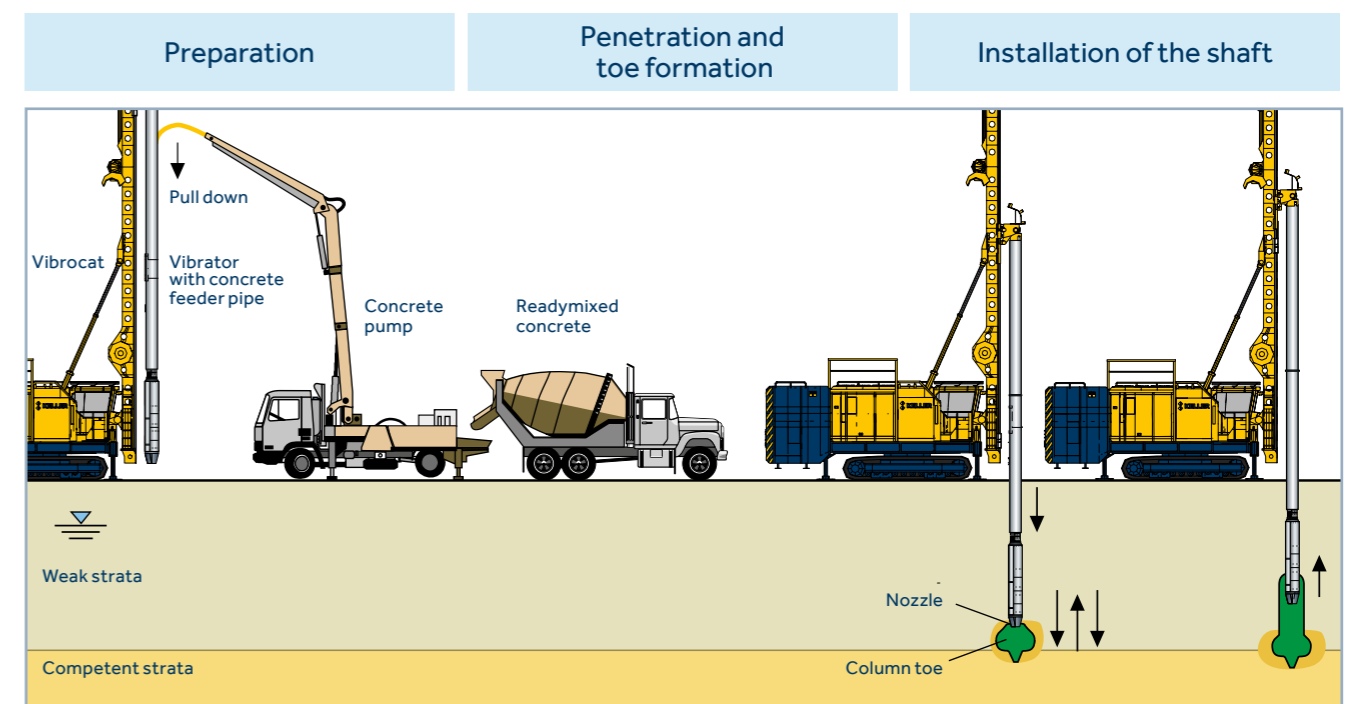

# Quality control and quality assurance

For all vibro techniques, electronic measuring devices can be employed to ensure and record constant high quality of workmanship.



## The measurement results

During compaction a number of different site and production parameters are automatically recorded. Values such as time, depth, penetration/pullout speed, pull-down force and current can be graphically displayed and printed. If required, the energy consumption can be recorded.

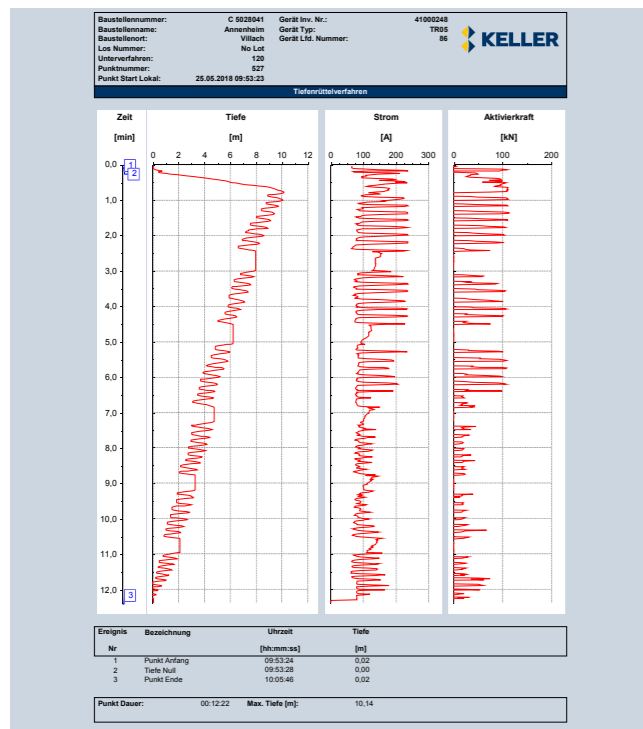

# Special applications

## Multiple vibrators and offshore compaction

Vibro compaction of large areas both onshore and offshore can be carried out with multiple vibrator assemblies.

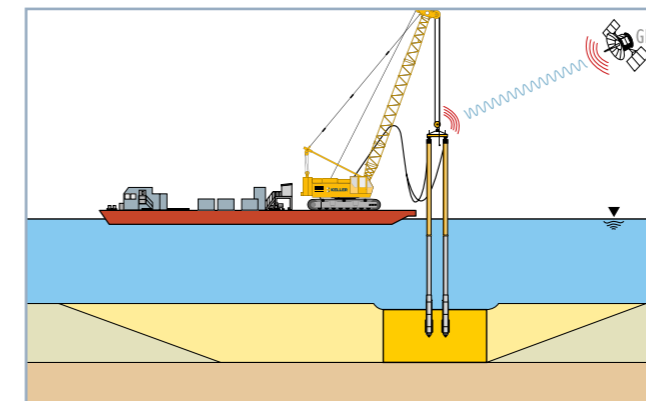

For vibro replacement offshore, such as for quay walls and bridge piers, a special gravel pump is used to construct columns with the bottom feed process.

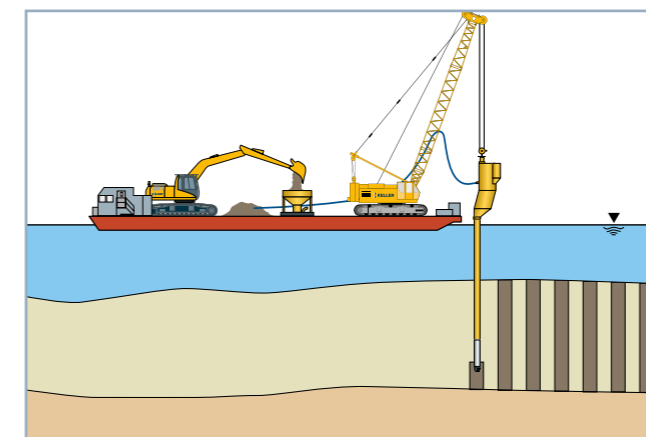

## Vibro replacement – top feed method

Stone columns in cohesive soils can be executed via the top feed method using crane-hung vibrators similar to a vibro compaction setup. The flushing medium assists rapid penetration into the ground. It stabilises the annulus around the vibrator so fines can be transported out from the soil and the ring created for gravel to be transported from the top to the bottom. It can also be used to increase the column diameter.





**Keller Africa**

Geotechnical specialist contractor  
[www.keller-africa.co.za](http://www.keller-africa.co.za)